

Operating-Instructions for the Control Units for Vibratory Drives

ESR 3000
ESM 3000

UL / CSA - Design



BA

Rhein-Nadel Automation GmbH

Contents

Table of contents

Chapt.....	Page
1 General.....	3
2 Function.....	3
3 Constructon	5
4 Technical Data.....	6
5 Ordering Codes.....	6
6 Settings.....	7
7 Control elements	8
8 Commissioning.....	9
9 Setting instructions.....	11
10 Error messages.....	15
11 Connections for enclosed construction.....	16
12 Connection for 6A panel mounting versions.....	18
13 Dimensions Enclosed construction.....	19
14 Dimensions panel mounting	20
15 Service appendix.....	21



Declaration of conformity
as defined by
Low voltage directive 2014/35/EU
and EMC directive 2014/30/EU

Herewith we declare that the product complies with the following provisions:

Low voltage directive 2014/35/EU
EMC directive 2014/30/EU

applied harmonized standards:

DIN EN 60204 T1
EN 61439-1

remarks:

Rhein-Nadel-Automation

Managing Director
Jack Grevenstein



Technical safety instructions for the user

This description contains the necessary information for the correct application of the product described below. It is intended for use by technically qualified personal.

Qualified personnel are persons who, because of their training, experience and position as well as their knowledge of appropriate standards, regulations, health and safety requirements and working conditions, are authorised to be responsible for the safety of the equipment, at all times, whilst carrying out their normal duties and are therefore aware of, and can report, possible hazards (Definition of qualified employees according to IEC 364)

Safety Instructions

The following instructions are provided for the personal safety of operators and also for the protection of the described product and connected equipment.



Warning!

Hazardous Voltage

Failure to observe can kill, cause serious injury or damage

- Isolate from mains before installation or dismantling work, as well as for fuse changes or post installation modifications.
- Observe the prescribed accident prevention and safety rules for the specific application.
- Before putting into operation check if the rated voltage for the unit conforms with the local supply voltage.
- Emergency stop devices must be provided for all applications. Operation of the emergency stop must inhibit any further uncontrolled operation.
- **The electrical connecting terminals must be covered!**
- **Earth bonding must be tested for integrity after installation.**

Specified Use

The units described herein are electrical controllers for installation in industrial plant. They are designed for controlling vibratory feeders.

Technical safety instructions for the user

This description contains the necessary information for the correct application of the product described below. It is intended for use by technically qualified personal.

Qualified personnel are persons who, because of their training, experience and position as well as their knowledge of appropriate standards, regulations, health and safety requirements and working conditions, are authorised to be responsible for the safety of the equipment, at all times, whilst carrying out their normal duties and are therefore aware of, and can report, possible hazards (Definition of qualified employees according to IEC 364)

Safety Instructions

The following instructions are provided for the personal safety of operators and also for the protection of the described product and connected equipment.



Warning!

Hazardous Voltage

Failure to observe can kill, cause serious injury or damage

- Isolate from mains before installation or dismantling work, as well as for fuse changes or post installation modifications.
- Observe the prescribed accident prevention and safety rules for the specific application.
- Before putting into operation check if the rated voltage for the unit conforms with the local supply voltage.
- Emergency stop devices must be provided for all applications. Operation of the emergency stop must inhibit any further uncontrolled operation.
- **The electrical connecting terminals must be covered!**
- **Earth bonding must be tested for integrity after installation.**

Specified Use

The units described herein are electrical controllers for installation in industrial plant. They are designed for controlling vibratory feeders.



For use in NFPA 79 Applications only

Adapters providing field wiring means are available from Rhein-Nadel Automation GmbH. Refer to Rhein-Nadel Automation GmbH.

1.0 General

The ESR 3000 – ESM 3000 range comprises special, adaptable controllers for use with vibratory feeders. The units generate an output frequency, to drive feeders, that is independent of mains frequency and so exact tuning with springs is not necessary. The feeders also run quieter because of the sinusoidal output signal. The adjusted output frequency corresponds to the mechanical vibrating frequency of the feed system. The optimum frequency setting for a feeder can be determined manually or automatically in regulation mode.

Depending on the version, the controller can be used in regulation mode, working in conjunction with an accelerometer fitted to the feeder, to operate at resonant frequency. In this way a constant component feed rate that is unaffected by load changes can be achieved. In regulation mode the vibrating frequency is also dynamically adjusted to compensate for resonant frequency changes caused by load changes. In normal operating mode (without accelerometer) the feeder remains constant at the set frequency. In both operating modes the feeder throughput is determined by the output voltage level.

Totally enclosed or panel mounting units can be supplied.

Notable Features:

- Adjustable output frequency, independent of mains frequency
- Adjustable minimum and maximum limits for the frequency range
- Adjustable current limit for the maximum coil current
- Constant feeder throughput irrespective of mains fluctuations
- Regulation control, with independent frequency search (resonance)
- On/Off status relay
- Track control
- 24 VDC output for operating a solenoid e.g air valve
- Four user setting memory locations
- Optional RS232 or Profibus-DP interface for remote parameter setting.

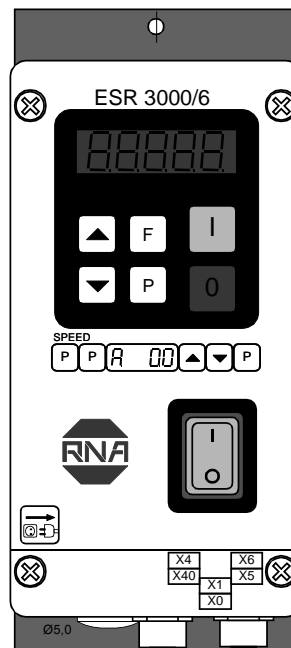

Enclosed version

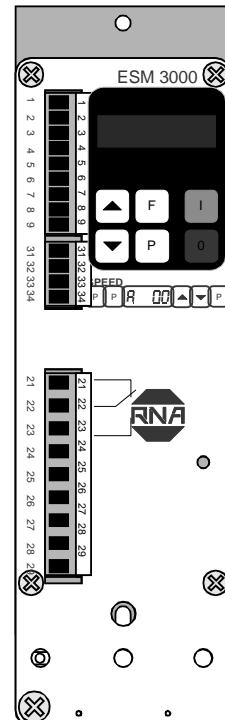

Panel mounting version

1.1 EC Conformity

The control device corresponds to the following regulations:

Low voltage directive 2014/35/EU
EMC directive 2014/30/EU

Applied harmonized standards:

DIN EN 60204 T1
EN 61439-1

2.0 Function

The unit is set up by using the touch panel on the front plate (buttons and LED display). All settings can be made by using the touch panel and a series of menus. The various parameters can be selected by entering operator codes. A fuller description of the parameters can be found in the section on settings. Alternatively, the feeder throughput can be adjusted by using an external potentiometer, an external voltage signal 0...10 V, DC or a current signal 0(4)...20 mA (the chosen option must be selected in menu 003). A relay with potential free contacts is provided for feeder status indication and this operates in conjunction with the feeder enable signal. Terminals for these contacts can be found inside the controller. During normal operation the set point is displayed as a percentage in the LED window. In the programming mode the selected dimension, as described in the setting up instructions, is shown. Changed settings can be stored by leaving the programming mode or automatically saved by not pressing a key for a period of 100 seconds.

The control units can provide a frequency range from 5...300 Hz, which can be limited by adjustable, upper and lower frequency limits. The usable adjustment range cannot exceed a ratio of 1:4, i.e. the upper frequency limit cannot be more than four times the lower frequency limit. It is possible to have a narrower setting of the limits and this provides a margin of safety against too wide a difference in the vibrating frequency.

The maximum output current drawn by the coil can be determined by integrated current limiting.

Critical parameters such as the current limit and vibrating frequency range are held under a special service menu. This menu cannot be accessed through the normal menu structure and an additional code number has to be used to gain access. This prevents unauthorised adjustment of these sensitive parameters.

An interface option can be used to provide an RS232 or Fieldbus (Profibus-DP) connection.

2.1 Track control

The output can be switched ON and OFF from a track component sensor, using internal, adjustable time delays (ton and toff).

The queue of components rises above and drops below the track sensor position. The controller

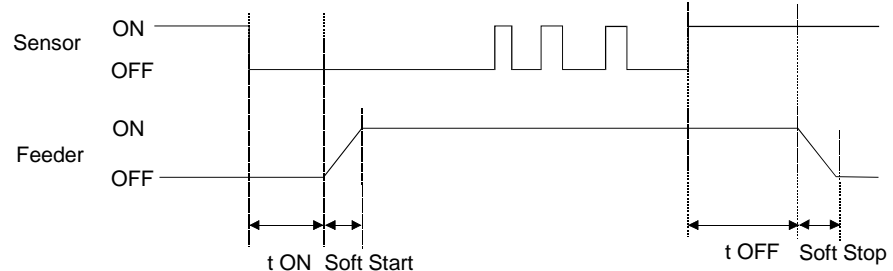

output switches on when the sensor cannot detect product and a switch-on time delay has elapsed. The output is switched off when product is detected and a switch-off time delay has elapsed (FULL displayed in the LED window). Gaps in the product feed cause resetting of the time delay. The time will always be precise from the last or first component, respectively. The ON and OFF time delays are set in the programming menu. The first decimal point in the display blinks to indicate that an internal timer is running.

An additional "Sensor-Time-out" timer is started when the feeder switches on. This can be set (30...240 sec.) to switch off the feeder if no product is sensed in the time out period. The status relay indicates that the feeder is not running and the LED window displays ERROR and SE alternately. This function is optional and must be selected in the Track Settings Menu with function EE = 1.

2.2 Operating with two speeds (2 set points for coarse/fine switching)

Coarse/Fine control can be used instead of track control (Menu C 003). The second set point is activated through the same sensor input that is used for track control. Either contacts or a 24 VDC signal can be used to change the set point from coarse to fine. The second set point is activated, immediately, by applying a 24 V signal

(The track control function is invalid)

2.3 Control inputs and output

2.3.1 Enable input

External switch or 24 VDC signal voltage.

External control function to switch the power output ON or OFF e.g. Networking of several controllers from a central PLC.

2.3.2 Sensor input for track control

Sensor for monitoring the queue of components on the track or an input for switching to the second set point 24 VDC (PNP).

2.3.3 External set point

The feeder amplitude set point can be provided from an external, analog 0...10 V, DC, 0(4)...20 mA, or a 10 kR Potentiometer. Parameter ESP in Menu C003 must be set to 1, for an external set point source to be used (not on 16A units).

Setting the minimum output value when external set point = 0:-

Before changing the ESP parameter to accept an external set point source, the minimum value can be adjusted by using the cursor keys, on the front panel, and this will remain when the ESP is changed over from 0 to 1.

2.3.4 Output status relay

Status-Relay contact 250 V/1 A (changeover). Relay closes when the feeder is running – the relay opens when there is no enable signal or a fault displayed.

2.3.5 Time-Out output 24 VDC

"Time Out" message active, if after adjusted time no material is recognized by the sensor (adjustable with parameter "E."). (not on 16 A units)

2.3.6 Air valve output 24 VDC

Output for air blast, comes on with feeder and switches off, 4 sec., after feeder stops (not on 16A units)

2.4 Display

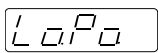

Initialisation phase, when supply voltage is connected (left decimal point blinks).

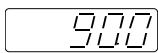

Normal Mode: The throughput set point is displayed

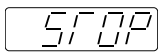

Output locked via enable input

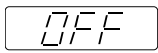

Output switched off via keyboard ("0" key)

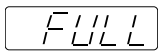

Output switched off by the track control sensor

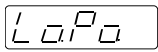

Under voltage, input voltage is too low.

3.0 Construction

The units are available as stand-alone, enclosed or panel mounting versions .

3.1 Enclosed units

- Mains switch

- Touch panel with display
- Mains cable with plug
- Output cable or output socket for connecting to the feed system
- Sensor socket. The standard unit has provision for 24 VDC sensors with a PNP output

3.2 Panel mounting units

- Touch panel with display
- Terminals for electrical connections
- Screw hole fixings for mounting

4.0 Technical Data

Model Type	ESR 3000 / 6A	ESR 3000 / 12A	ESM 3000 / 6A	
Supply voltage	110 V, 240 V +/- 10 %, 50/60			
Output	0...95 V, 0...205 V			
Output current	Max. 6 A	Max. 12 A	Max. 6 A	
Recommended Protection	10 A Anti-surge Type D current trip device	16 A Anti-surge	16 A Anti-surge	16 A Anti-surge
Fine-wire fuse internally	Fine-wire fuse 5x20 10 Amp. T-T			
Enable	24 V, DC input (connect to internal 24 V reference)			
Status relay	Change-over contacts, 250V, 1 A			
Sensor supply	24 V, DC, 100 mA			
Sensor type	PNP output			
Status output	Relay, change-over contact 1A, 250 VAC , 60 VDC			
Solenoid valve output	24 VDC / 50 mA switched with feeder unit (PNP), short-circuit protected			not provided
Operating temperature	0...+45 °C			
Storage temperature	-10...+80 °C			
Altitude	1000 m 0,5 % rated current reduction for each additional 100 m			

* The units are provided with switch-on, current damping. However it is still possible that some internal capacitor, energising, current spikes will be generated, especially when several units are switched on simultaneously. Therefore, fuses and overload trips should have anti current surge characteristics.

5.0 Ordering Codes (Standard units)

Type	Construction
ESR 3000 / 6 A – IP54	6 A, Enclosed construction with track control and accelerometer regulation
ESR 3000 / 12A – IP 54	12 A, Enclosed construction with track control and accelerometer regulation
ESM 3000 / 6A – IP20	6 A, Panel mounting with track control and accelerometer regulation

For use in NFPA 79 Applications only

E217179

Adapters providing field wiring means are available from Rhein-Nadel Automation GmbH.
Refer to Rhein-Nadel Automation GmbH.



6.0 Settings

After checking the correct operation of the controller in conjunction with the vibratory feed system it is advisable to restrict the user to feeder throughput settings only.

Setting the feeder throughput:

Press the P key twice and adjust the throughput with the cursor keys (Code C. 000).

Parameter:		Code	Factory setting:	Entry Code:
Vibratory feeder				
• Amplitude (throughput)	0...100 %	A.	0 %	000, 002

The following variable parameters are available for setting up the feed system

Parameter:		Display	Factory setting:	Entry Code:
Vibratory feeder				
• Amplitude (throughput)	0...100 %	A.	0 %	000, 002, 020 096
• Maximum control limit (U_{max})	5...100 %	P.	90 %	008, 020, 096
• Vibrating frequency	35...140 Hz (5...300 Hz)	F.	100 Hz	008, 020 040, 096
• Soft start ramp up	0...60 Sek.	/.	0,1 Sek.	020, 096
• Soft stop ramp down	0...60 Sek.	\.	0,1 Sek.	020, 096
• Switch to external set point	0 / 1	E.S.P.	0	003
• Set point 0(4)...20 mA	0 / 1	4.20	0	003
• Potentiometer set point	0 / 1	POT.	0	003
• Coarse / Fine control	0 / 1	S.P.2.	0	003
• Invert enable	0 / 1	-En.	0	003
• Pulse feed	0 / 1	HOP.	0	064
• On time delay (only if HOP. = 1)	0...60 Sec.	H.	1,0 Sec.	004, 064
• Off time delay (only if HOP. = 1)	0...60 Sec.	h.	1,0 Sec.	004, 064
• Invert hopper sensor (not active)	0 / 1	-Ho.	0	004, 064
Track control				
• Switch on time delay	0...60 Sec.	I.	1 Sec.	007, 167
• Switch off time delay	0...60 Sec.	O.	1 Sec.	007, 167
• Invert sensor	PNP / PNP invers	-SE.	PNP	007, 167
• Sensor Time-out	0 / 1	E.En.	0	015, 167
• Sense time delay (Sensor Time-out)	1...240 Sec.	E.	180 Sec.	015, 167
• Switch off time air valve	0...60 Sec.	A.i.	4 Sec.	015
Service				
• Display actual output current		i.		040
• Display actual frequency		F.		040
• Save user settings		PUSH.		143
• Recall factory settings		FAC.		210
• Recall user settings		US.PA.		210
• Hide programming menus	0 / 1	Hd.C.	0	117
• Hide set point adjustment	0 / 1	di.S.	0	137
• Display software version				001

7.0 Control elements

7.1 Settings

The six buttons and a LED display found in the front panel, are used for operating and setting up the unit. All operating methods and adjustable parameters can be set up through this panel.

The "I" and "O" buttons are used for switching the unit ON and OFF, however, **these do not provide mains isolation**, they simply inhibit the power semiconductors

The "P", "F" and "Cursor Buttons" are used for parameter adjustment. Parameters are set by using menu controls which are called up by entering operator codes. The functions are described in greater detail in the section on setting instructions.

The display value can be increased or decreased by units, or tenths of units, by a short press of the cursor buttons. Holding the buttons down will cause the display to change in units of ten.

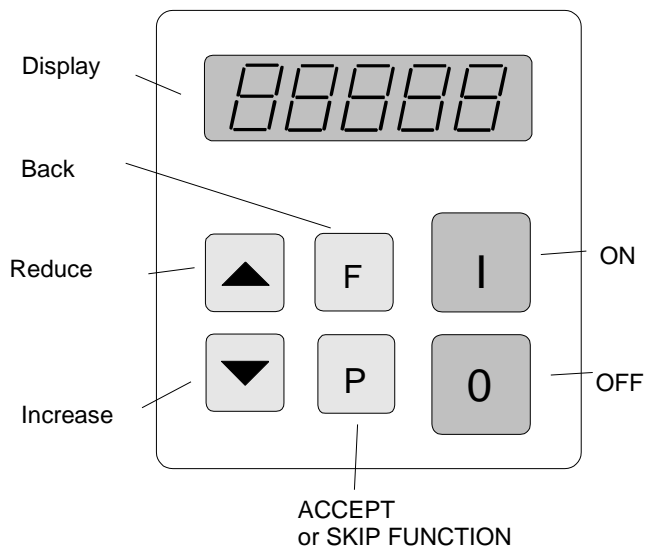

To prevent accidental or unauthorized adjustment the adjustment parameters, in the user menus, are protected. A code must be entered to open the user menus. There are different pass codes for each function group.

Setting adjustments are automatically saved upon leaving the programming mode or if no button is pressed for a period of 100 seconds.

All setting routines are commenced by pressing the programming button "P". The following diagram should clarify the sequence in which keys are pressed:-

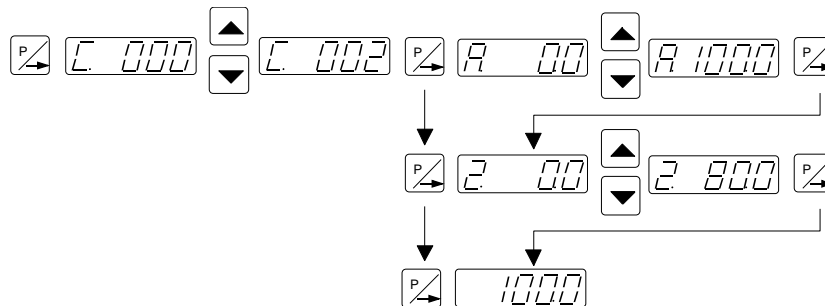

1. Press the "P" key.
2. Select the code number with the cursor keys.
3. Press the "P" key. This displays the first menu point. The required menu point can be found by repeatedly pressing the "P" key (scrolling).
4. The value in the menu point can be changed with the cursor keys.
5. Scroll to the next menu point or to the end of the menu, which returns the display to the set point value, by pressing the "P" key. To exit the menu and return back to the normal display, quickly, depress the "P" key for 5 seconds.
6. To return back to the previous position in the menu, press the "F" key.

8.0 Commissioning

8.1 Assembling position



Please fasten the devices on a vibration-free underground and take care for sufficient air circulation.

8.2 Preliminary steps

- Check that the unit is correct for the local mains supply (rating plate information) and that it is correctly rated for the feed system.
- Connect the controller according to the connection diagram
- When applications with frequently on and off cycles are required, use the intended enable input. It is prohibited to open the current circuit with a switch or a contactor while the feeder is running.

8.2.1 Important points



Using the control units described in this document, it is possible to adjust the feed system that it runs in resonance. In this condition it is possible to obtain excessive output for a very low set point setting. Therefore extreme care should be taken to avoid causing damage to the drive coil, through hammering.

In practice it is not possible to run at resonant frequency without accelerometer feedback because the system would be unstable and uncontrollable. The system must be set safely off resonance i.e. either above or below the natural frequency.

Resonant frequency: Depending on the spring and mass design of the feeder system it is possible to have resonance at more than one frequency. These additional resonance points are multiples of the main frequency. For this reason in critical situations it is possible that the automatic frequency search will not find true resonance and in such cases the natural frequency must be determined manually.

8.2.1.2 Operating frequency of the feeder coil

It is possible that the current flowing through the coil will increase for a small frequency adjustment. and so this should be checked with a true RMS instrument for each new application as well as monitoring the coil for heat build-up.

The coil should be designed for the correct operating frequency to prevent excessive current draw and the consequential overloading of the coil.

8.2.1.3 Measurement of the output voltage and current

The voltage and current cannot be measured with a regular instrument because the controller output uses an electronic inverter with a pulse width modulation signal. An effective measuring instrument such as a moving iron meter (analog) must be used. It is recommended that an analog instrument is used rather than an electronic multi-meter which will give a misleading reading.

8.3 Putting the equipment into operation

1. Establish the vibrating frequency.
2. Establish the power of the feed system (maximum permissible current draw).

For a new feeder where settings are unknown: (see also comments below)

Without connecting the feeder, select parameter FAC in menu C210 (reset factory settings), press the cursor key to reset (SAFE) and press the P key to leave the menu. The factory settings are listed in the table in section 7, headed settings

! Comments !

It is possible that a special parameter set, for a machine manufacturer, has been pre-stored under a user code and these can be recalled. In such instances specific machine settings will be loaded and so the next steps are not relevant.

Basic settings:

- Connect feeder.
- Set frequency (refer to feeder data sheet). Menu C096 parameter F.
- Check current limit (refer to feeder data sheet). Menu C040 parameter I (shows the current limit as a percentage of maximum). If applicable use service menu for setting.
- Increase set point, observe feeder, check running.
- Increase set point to maximum and check if power needs limiting (hammering). If necessary adjust the limit as follows:-
- Adjust set point to zero
- Set parameter P (maximum limit) in Menu C096 to 50
- Adjust set point A to 100%.
- Increase the maximum limit P from 50% until the required amplitude is reached.
- The full set point range of 0...100% can now be used.

Additional settings e.g. soft start, time delays etc. can be set to suit the particular equipment.

Determining the output frequency (vibrating frequency)

It is essential that the output frequency is adjusted with the set point set at a low frequency, otherwise on hitting the resonant frequency it is possible to achieve a high amplitude with a low output voltage. An analog, effective value, current indicating unit (moving iron meter) must be connected into the output circuit.

Resonant is reached when there is a maximum amplitude for a minimum output current.

To achieve a stable feed system there must be an offset between the vibrating frequency and resonance (approx. 1...2Hz). This offset must be determined by the user because different feeders have different running characteristics.

9.0 Setting Instructions

9.1 User adjustment of throughput

Code C. 000

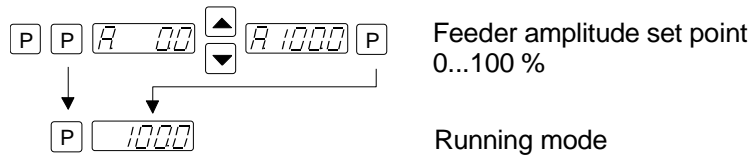

A further set point code can be found under C002
(for use in coarse/fine operation)

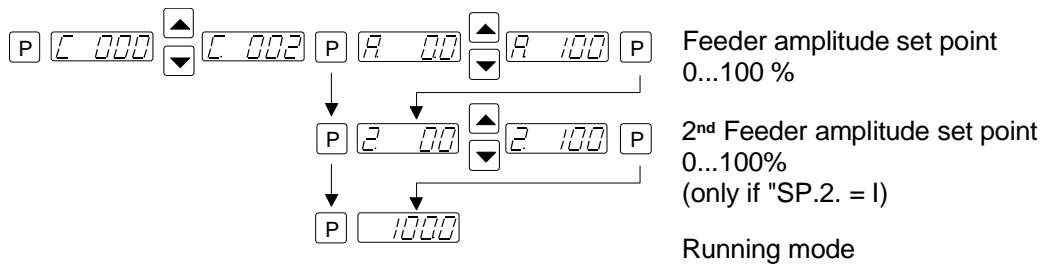

9.2 Tuning the feed system

9.2.1 Feeder settings

Code C. 020, 096

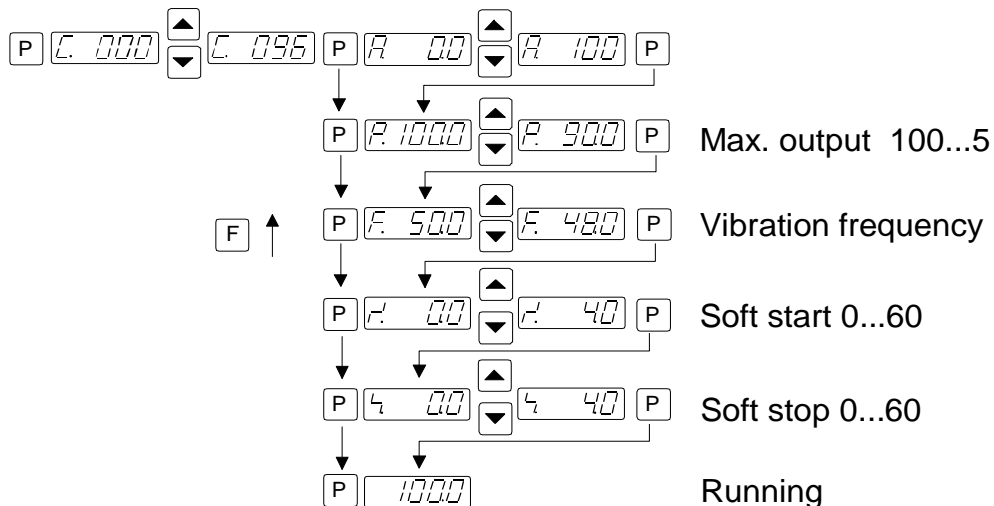

Setting the maximum limit

1. Adjust set point to zero
2. Set parameter P (maximum limit) to 50.
3. Adjust set point to 100%
4. Increase the limit P from 50% until the required amplitude is reached
5. The full set point range of 0...100% can now be used

9.2.2 Track control

Code C. 167, 007

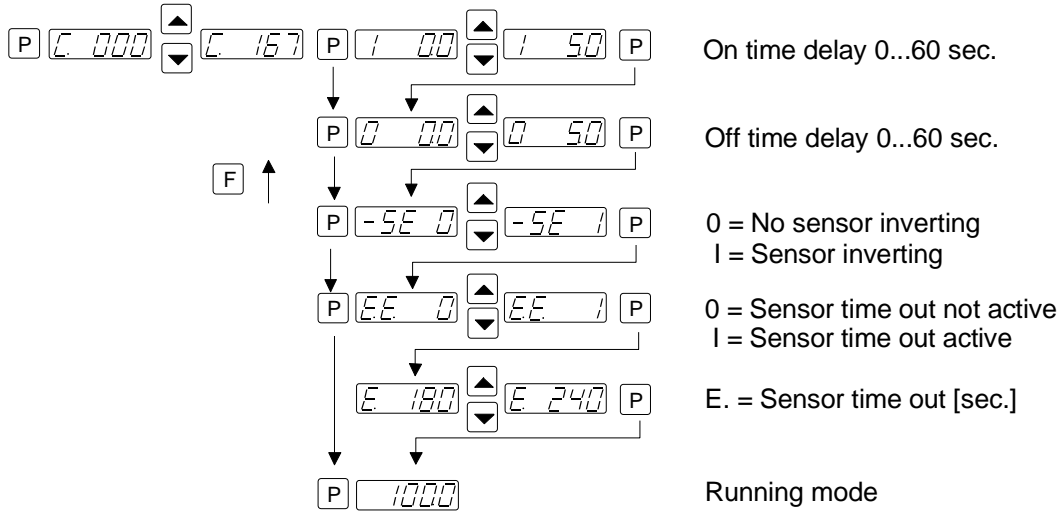

9.2.3 Sensor time out

Code C. 015

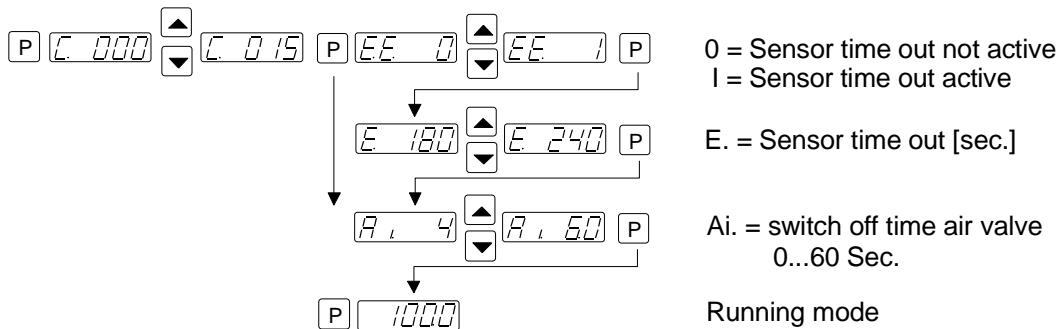

9.2.4 Set point source

Code C. 003

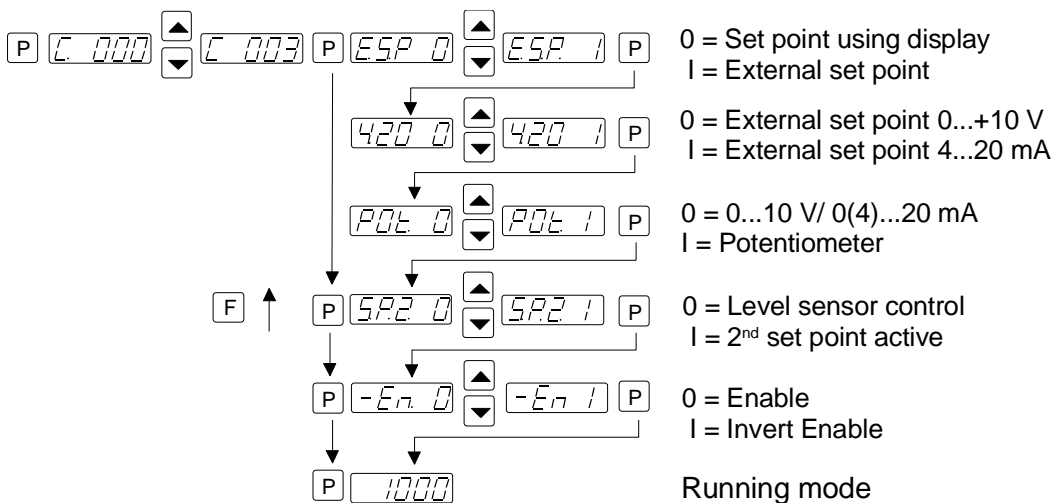

POT is not available on 16A units

9.2.5 Pulse feed

Code C. 004, 064

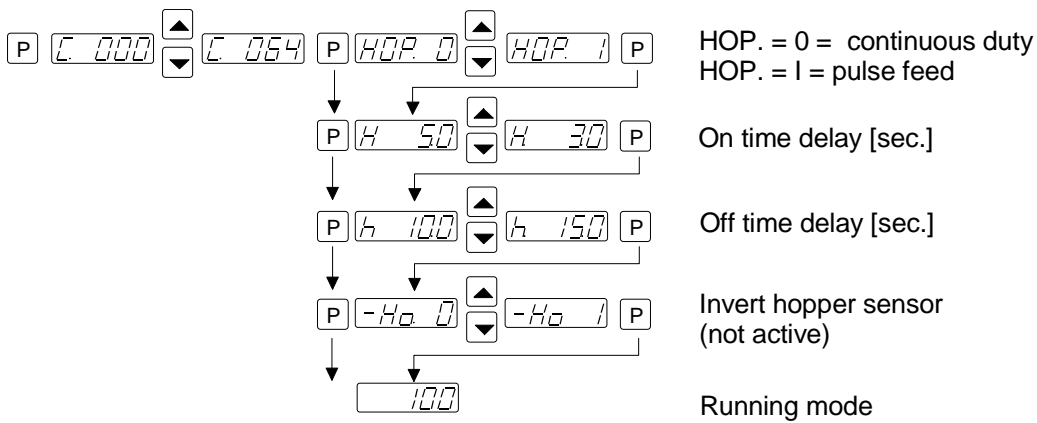

9.2.6.1 Determining the resonant frequency

Manual setting of the vibrating frequency

It is essential that the output frequency is adjusted with the set point set at a low frequency, otherwise on hitting the resonant frequency it is possible to achieve a high amplitude with a low output voltage. An analog, effective value, current indicating unit (moving iron meter) must be connected into the output circuit. **Resonant frequency is reached when there is a maximum amplitude for a minimum output current.**

To achieve a stable feed system there must be an offset between the vibrating frequency and resonance (approx. 1...2Hz). This offset must be determined by the user because different feeders have different running characteristics.

9.2.7 Display actual current and frequency

Code C. 040

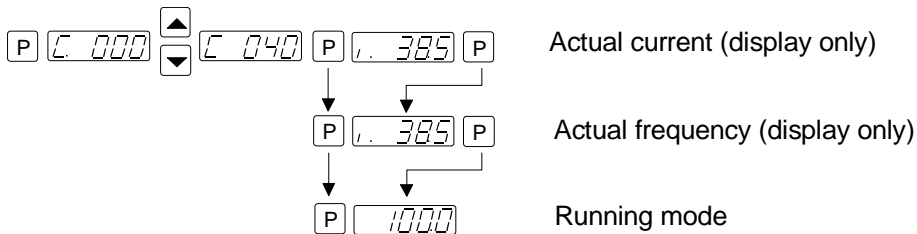

9.2.8 Save selected parameters

Code C. 143

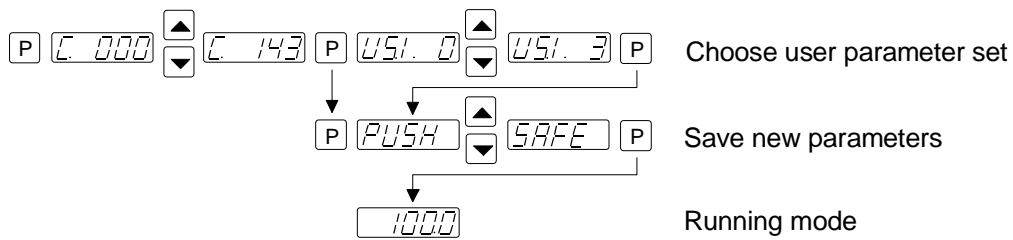

9.2.9 Recall user or factory settings

Code C. 210

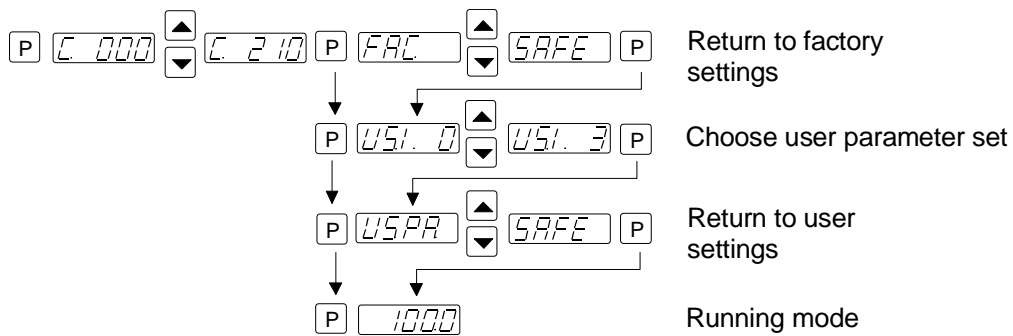

9.2.10 Hide parameter menus

Code C. 117

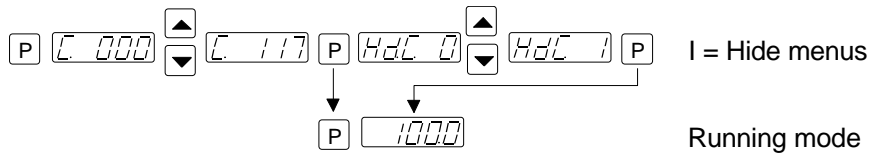

10.0 Error messages / ERROR reset

Errors are indicated by an alternating code and ERROR display

Overload limit

Output level exceeded e.g. incorrect frequency setting, coil air-gap too wide.

Error OL

Short circuit trip

Faulty coil, short circuit or defective cable..

Error SC

Over voltage

Supply voltage too high or back EMF from the coil at lower frequencies.

Error OV

Current spike limit

Frequency set too low for installed coil or frequency altered too rapidly during setting up.

Error PEA

Sensor fault (only when regulation mode is selected)

Accelerometer not working or faulty.

Error ACC

ERROR Reset through Menu C009

Sensor time out

After sensor time out has elapsed

Error SE

ERROR Reset is achieved by pressing touch panel keys 0 or I during normal operation or by using Menu C009.

In the event of an error check that this is not caused by incorrect wiring or cable faults. The error message, ERROR ACC, can also occur if regulation mode is chosen (in Menu C008) and an accelerometer is not connected, for example.

Reset the error in the following manner:-

ERROR RESET



Frequently appearing Errors, which are not described in this chapter, should be reported to the manufacturer.

11.0 Connections for enclosed construction

Internal connections for 3A – 8A units

When a potentiometer is connected parameter POT must be set to 1 in Menu C003..

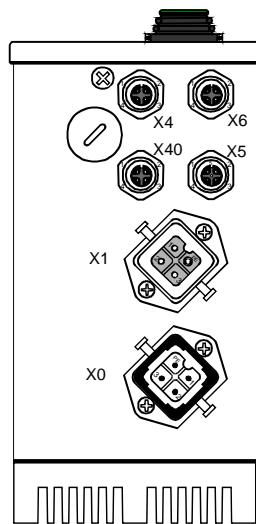
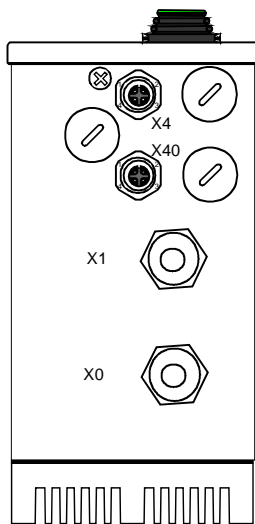
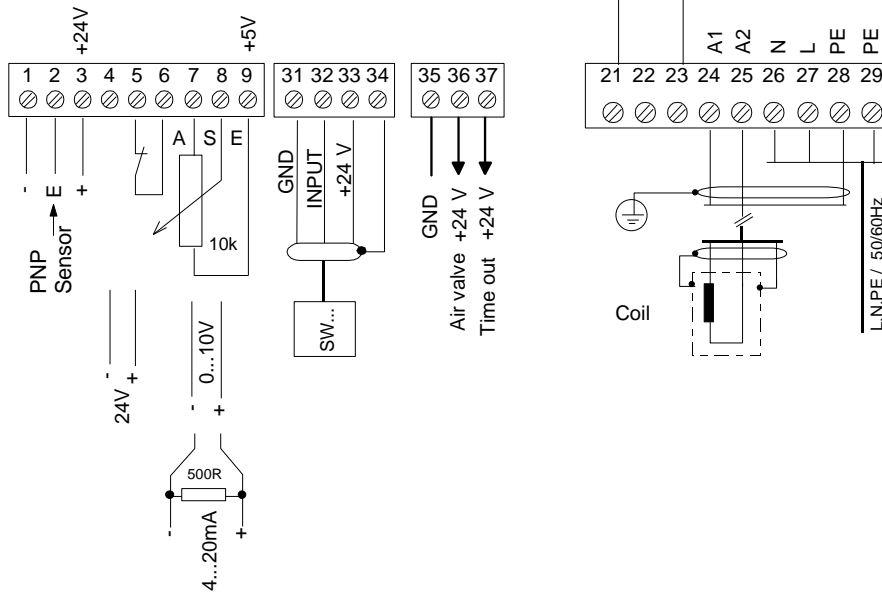

X4 Track sensor socket

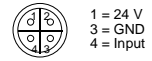

X40 Accelerometer socket

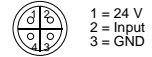

X6 Enable input socket

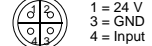

X5 Status output socket

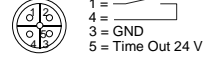

X1 Output Feeder

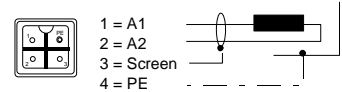

X0 Main supply
110 / 240 V,
50/60 Hz

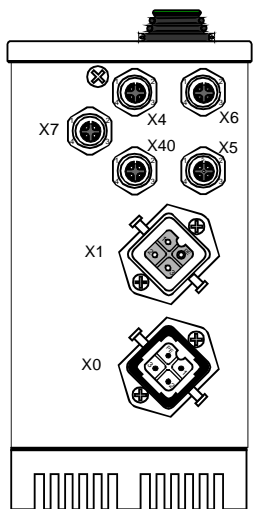
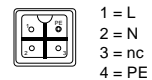

X4 Track sensor socket

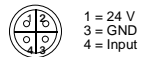

X40 Accelerometer socket

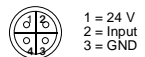

X6 Enable input socket



X5 Status output socket

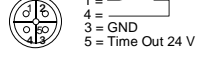

X7 Air valve socket

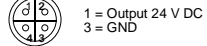

X1 Output Feeder

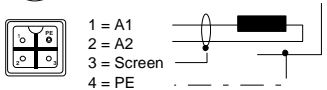

X0 Main supply
110 / 240 V,
50/60 Hz

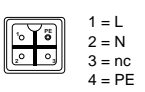

The output cable to the feeder must be screened to conform with EMC regulations.

11.1 Connections for enclosed construction

Internal connections for 12A unit

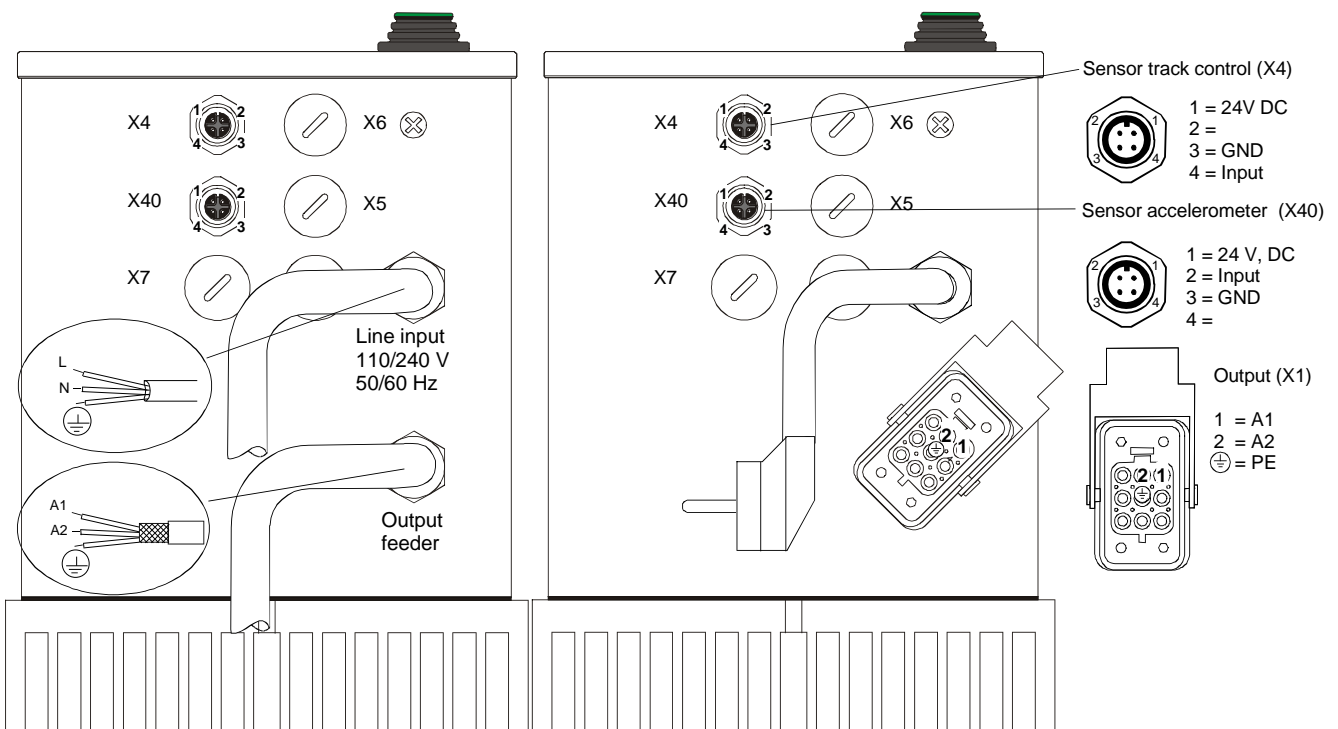
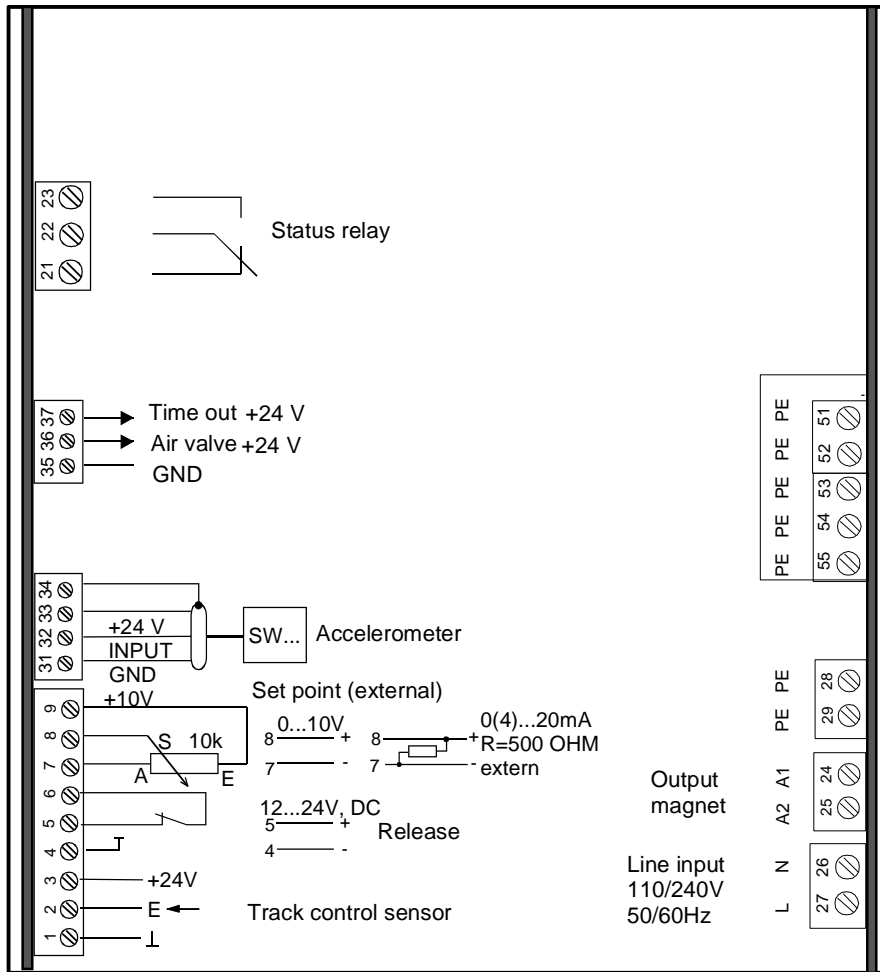

12.0 Connections for 6 A panel mounting versions

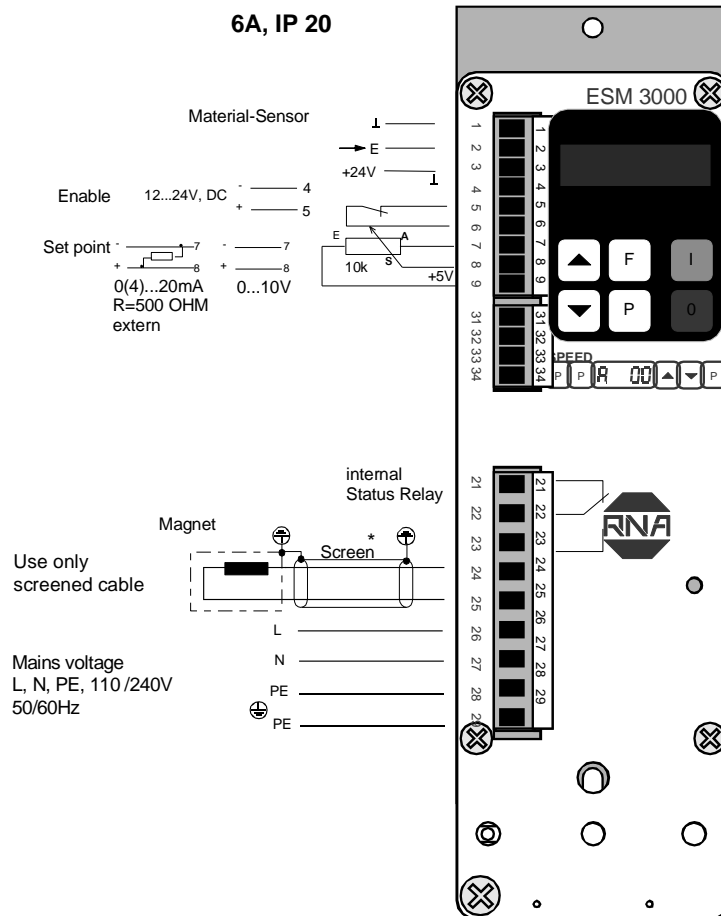

Recommended method of terminating screen of output cable

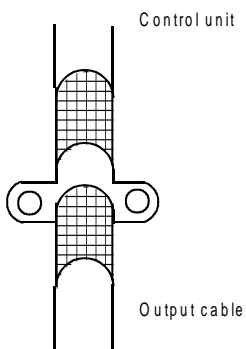

The output cable to the feeder must be screened to conform with EMC regulations.

When a potentiometer is connected parameter POT must be set to 1 in Menu C003..

13.0 Dimensions - Enclosed construction

Enclosed construction 6A

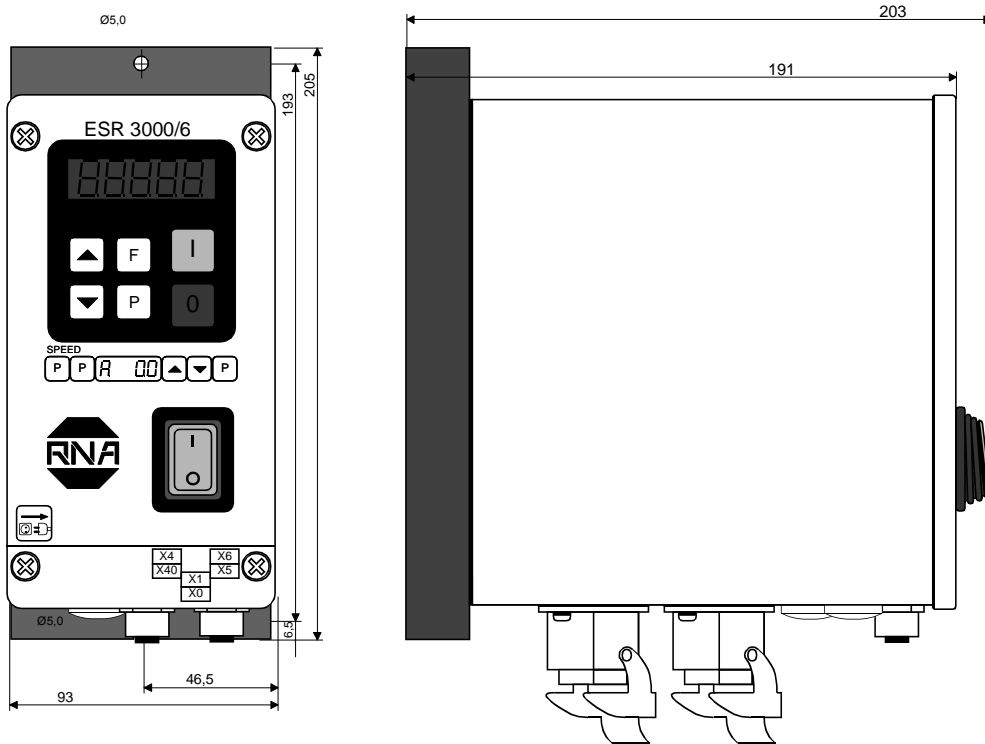

Enclosed construction 12A

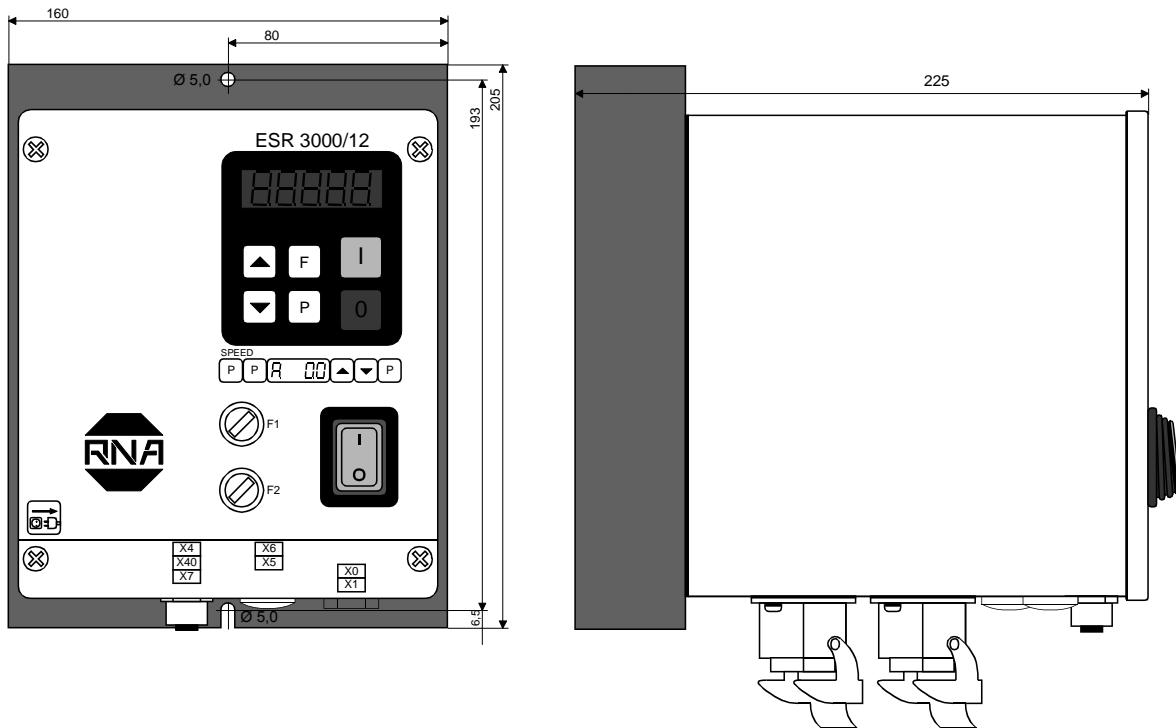

13.1 Dimensions – Panel mounting

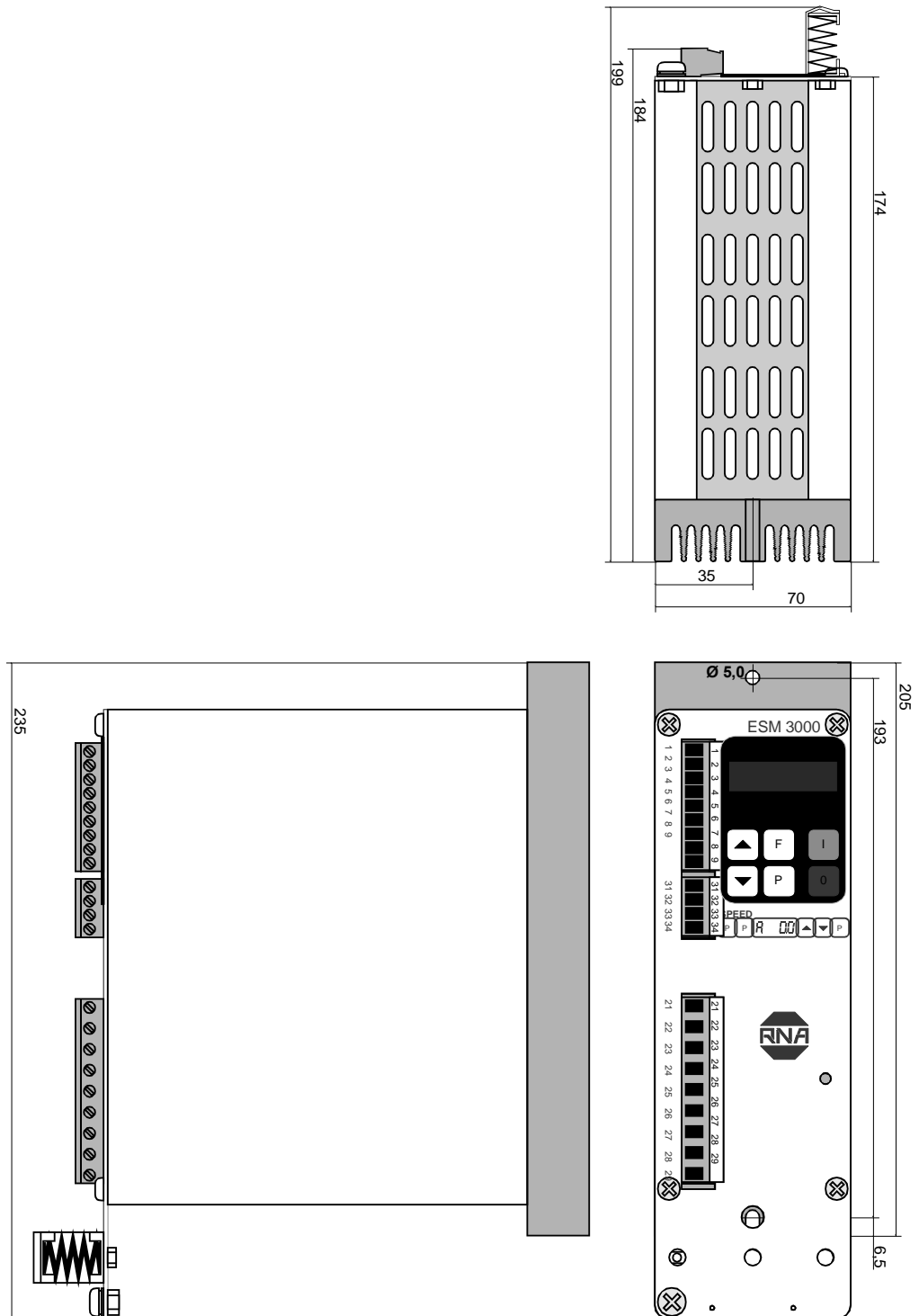

15.0 Service appendix

ATTENTION !

The settings described in this section relating to the service menu are intended for use by skilled persons because the functions and limits of the feed system can be greatly influenced by their adjustment

It is the responsibility of the supplier of the equipment to decide whether this information should be released or restricted for use by service engineers only.

The service menu cannot be accessed through the normal menu structure. It can only be enabled by using a special key code.

15.1 Service Menu

The critical parameters, current limit and user adjustable frequency range are held in a separate service menu. This menu cannot be reached through the normal menu structure and must be enabled by using an additional code number. This prevents the unauthorised changing of these sensitive parameters

- **Current Limit** – Protects the coil against overload.
The output current limit is set to the maximum current rating of the coil.
- **Frequency limits** – Protection against unhealthy operation.
The vibrating frequency limits available to the user are fixed.
- **Output voltage limit** 100 V
The output voltage limit allows 110v coils to be used on a 230V supply without damage.

Parameter:		Display	Factory setting:	Entry code:
• Enable service menu	0 / 1	En.C:	0	127
• Adjust current limit	0...100 %	I.	100	040
• Set lower frequency	5...300 Hz	F.L.	35	040
• Set upper frequency	6...300 Hz	F.H.	140	040
• Limit output voltage 100 V	0 / 1	P.Li.	0	040

15.2 Frequency adjustment range

The control unit is supplied with a maximum frequency range of 5...150Hz. Using an adjustable under and over frequency limits, the user range (parameter F) can be restricted to a maximum ratio of 1:4. In regulation mode, this restricted frequency range has great importance because it assists with the accurate determination of the measurement signals from the accelerometer. During the automatic frequency search a maximum sweep range of 1:4 is possible. The lower (FL) and upper (FH) frequency limits restrict the range. A narrow setting of the limits of less than 1:4 is possible and also advisable because this ensures that widely different changes of the frequency cannot occur when the user is setting up the system.

The range of the automatic frequency control (AFC) is also limited by these settings.

A practical setting is +/- 20 % of resonance.

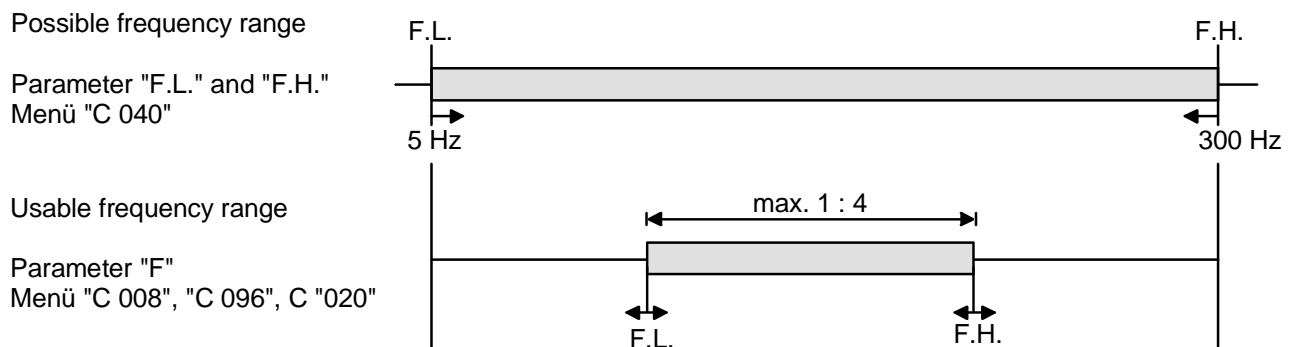

1. Set lower frequency limit.
2. Set upper frequency limit.

15.3 Current limiting

The current limit is used to set the controller for the rated current of the coil I_M . The current limit I_{MAX} is set by using parameter I. The displayed setting is expressed as a percentage of the controllers rated current I_N (100 % corresponds to the units rated current).

$$I_{MAX} = \frac{I_M \cdot 100}{I_N}$$

To protect the coils the current limit must be set to the rated current for the coil(s) I_M .

When several coils are connected in parallel the coil current is the sum of all individual currents.

Enable Service Mode

The actual service menu is accessed by opening the service mode.

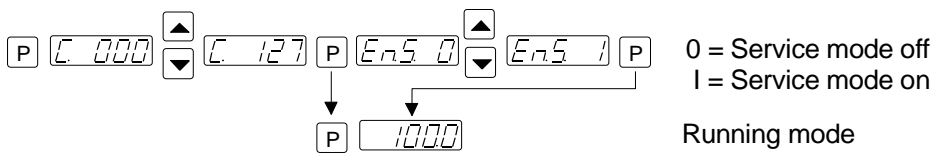

The normal service menu, containing the output current and frequency limit settings, is accessed by opening the service mode.

Service menu

Code 040

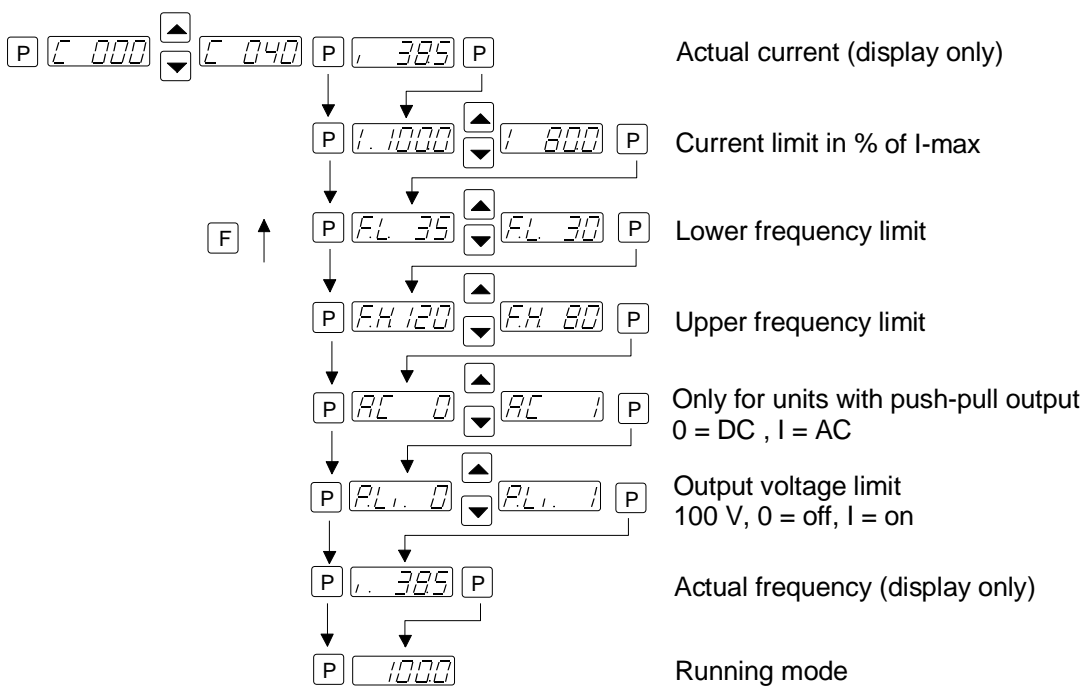

After making adjustments the service mode must be closed again!



D

Rhein-Nadel Automation GmbH

Reichsweg 19/23 • D - 52068 Aachen
Tel (+49) 0241/5109-159 • Fax (+49) 0241/5109-219
Internet www.rna.de • Email vertrieb@rna.de

Rhein-Nadel Automation GmbH

Zweigbetrieb Lüdenscheid
Nottebohmstraße 57 • D - 58511 Lüdenscheid
Tel (+49) 02351/41744 • Fax (+49) 02351/45582
Email werk.luedenscheid@rna.de

Rhein-Nadel Automation GmbH

Zweigbetrieb Ergolding
Ahornstraße 122 • D - 84030 Ergolding
Tel (+49) 0871/72812 • Fax (+49) 0871/77131
Email werk.ergolding@rna.de

PSA Zuführtechnik GmbH

Dr. Jakob-Berlinger-Weg 1 • D – 74523 Schwäbisch Hall
Tel +49 (0)791/9460098-0 • Fax +49 (0)791/9460098-29
Email info@psa-zt.de

CH

HSH Handling Systems AG

Wangenstr. 96 • CH - 3360 Herzogenbuchsee
Tel (+41) 062/95610-00 • Fax (+41) 062/95610-10
Internet www.rna.de • Email info@handling-systems.ch

GB

RNA AUTOMATION LTD

Hayward Industrial Park
Tameside Drive, Castle Bromwich
GB - Birmingham, B 35 7 AG
Tel (+44) 0121/749-2566 • Fax (+44) 0121/749-6217
Internet www.rna-uk.com • Email rna@rna-uk.com

E

Vibrant S.A.

Pol. Ind. Famades C/Energía Parc 27
E - 08940 Cornellà Llobregat (Barcelona)
Tel (+34) 093/377-7300 • Fax (+34) 093/377-6752
Internet www.vibrant-rna.com • Email info@vibrant-rna.com